

ARDUINO NANO SOCKET

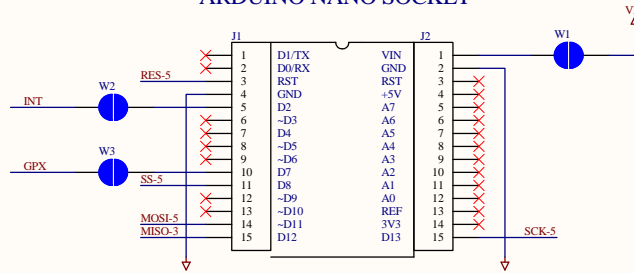

LEVEL SHIFTER

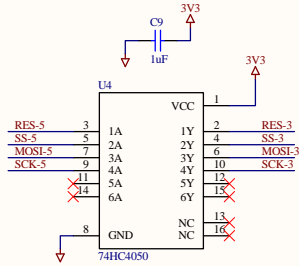

USB CONTROLLER

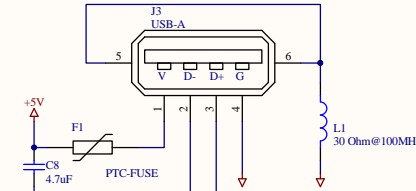
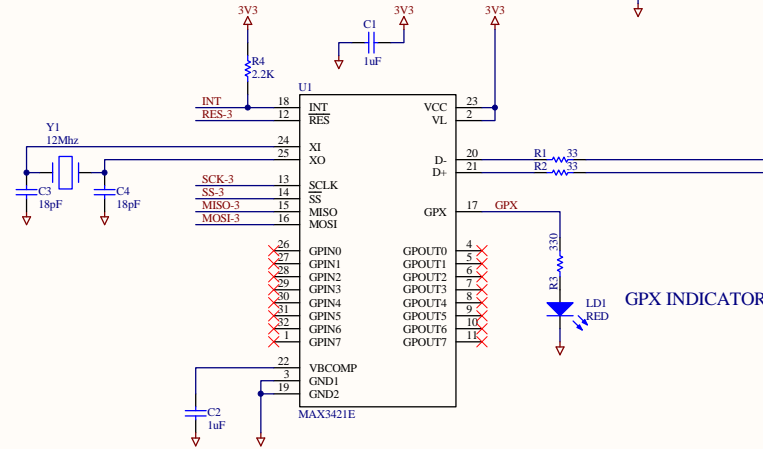

GPX INDICATOR

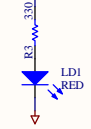

5V 1A VREG

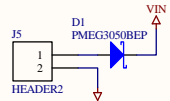

3.3V 250mA VREG

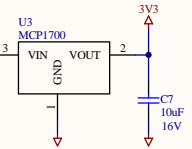

 GRAVITECH WWW.GRAVITECH.US		MADE IN U.S.A ELECTRONIC EXPERIMENTAL SOLUTIONS	
		TITLE: USBHOST-4NANO	
DWG NUMBER:		REV:	
DATE: *		SIDE:	SHEET: 1/1