

**PWR ON LED**

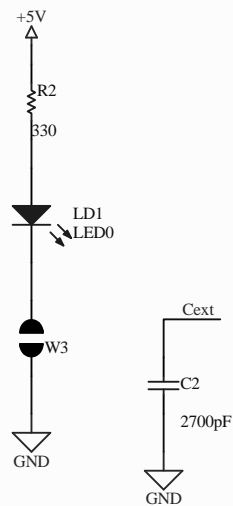

**I2C 4-DIG 7-SEG**

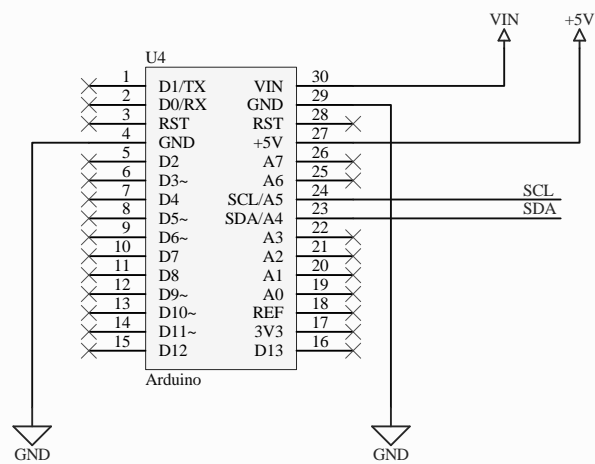
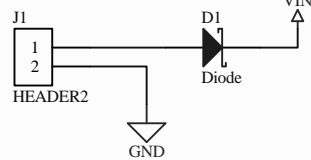
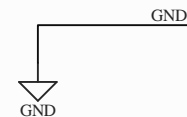
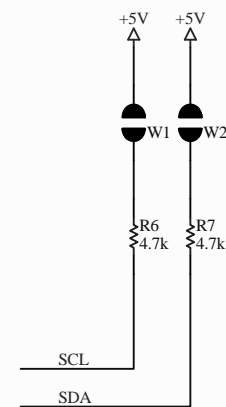
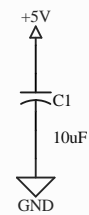
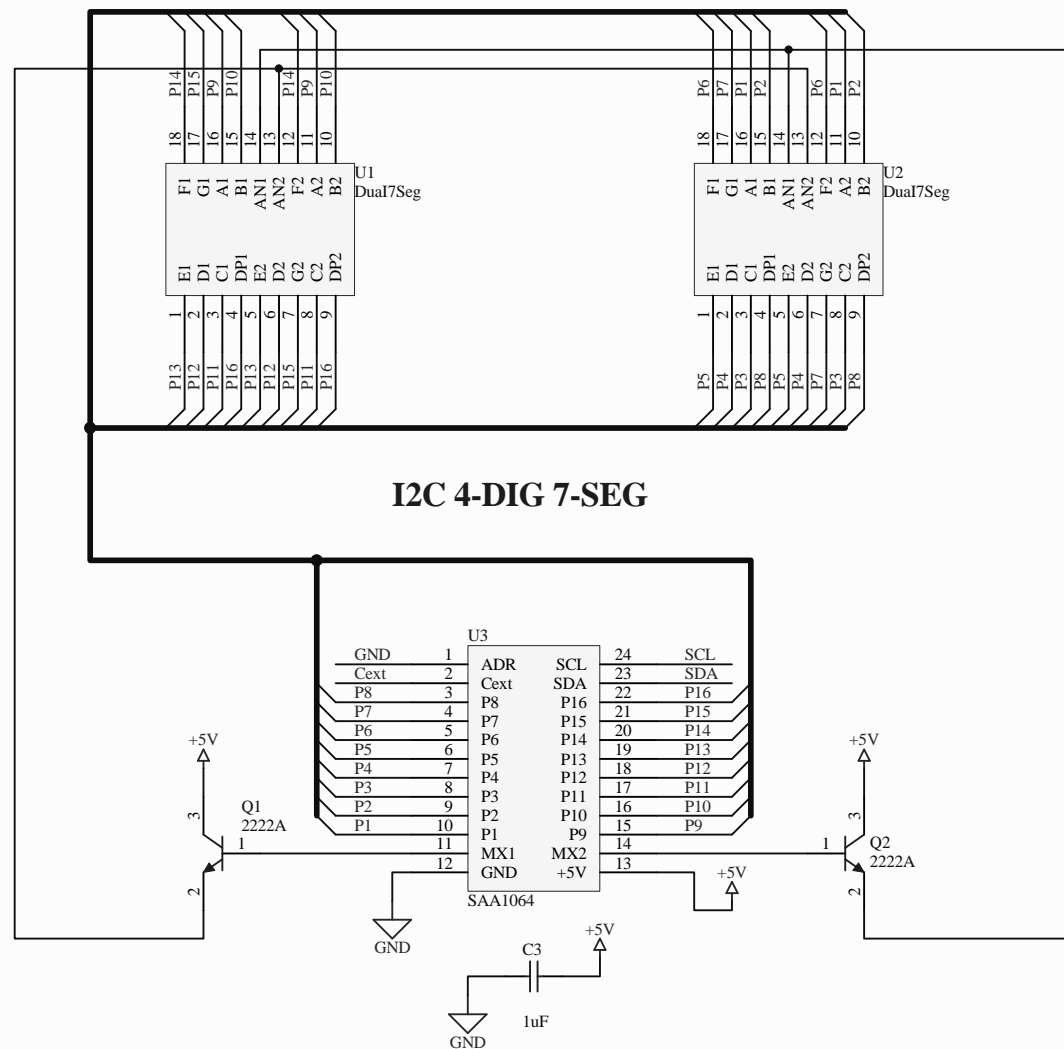

**GRAVITECH**  
WWW.GRAVITECH.US

**MADE IN U.S.A**  
ELECTRONIC EXPERIMENTAL SOLUTIONS

TITLE: 7SEG-4NANO		REV: 1.0
DWG NUMBER:	DATE: 5/03/2014	SHEET: 1
SIDE: 17X11		